

Channel Framed Mirror M1500 (Bright) & M1510 (Satin)

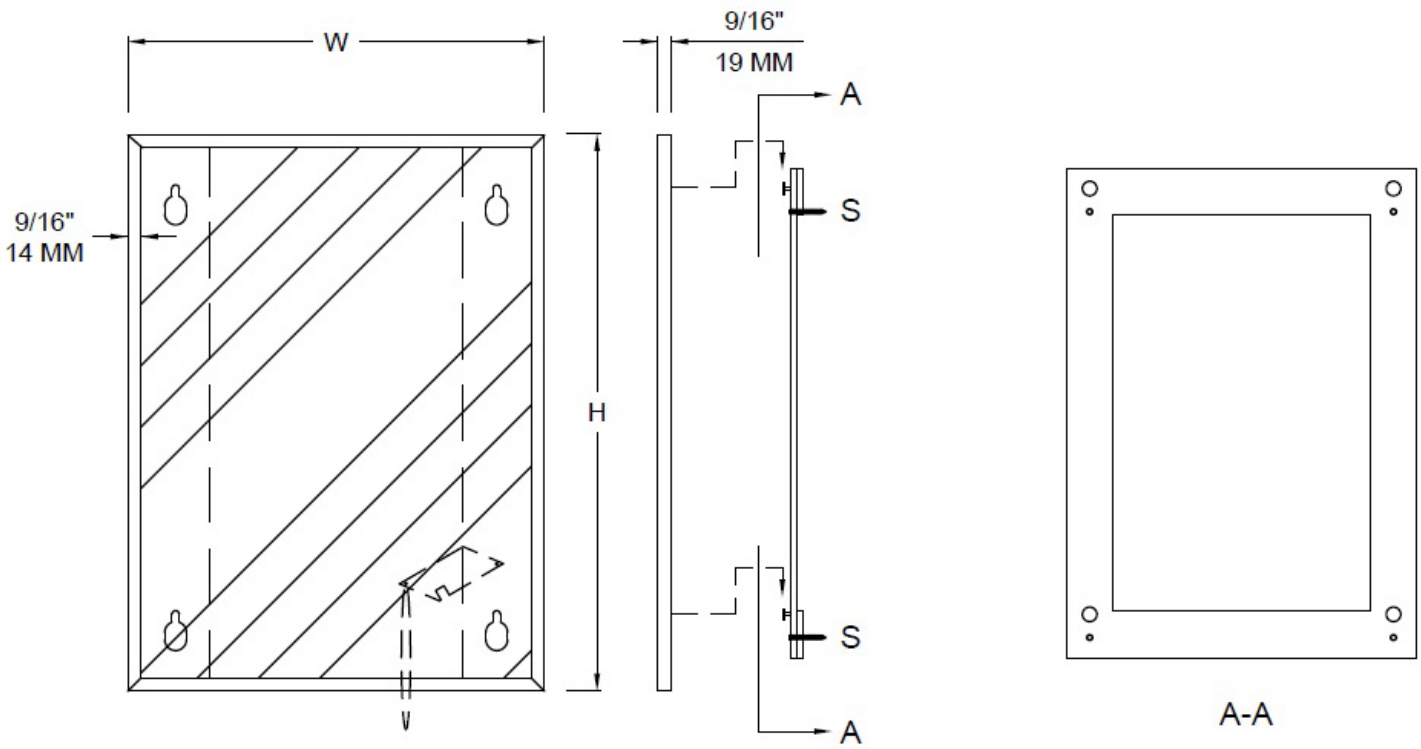

Architectural
Spec Sheet

6201 S. Zero Street
Fort Smith, AR 72903
(479) 646-3466
www.meekmirrors.com



◀ MIRROR: #1 Quality 1/4" (6MM) Thick Float Glass Mirror, electrolytic copper Back, Guaranteed for 15 Years against silver spoilage. Other Glazes available.

◀ MIRROR PROTECTION: Protected by shock-absorbing expanded polystyrene sheets.

◀ WALLPLATE: 22 gauge (.76MM) Quality corrosion-resistant galvanized steel strips with punched holes in support areas.

◀ BACKPLATE: 22 gauge (.76MM), Lock forming quality corrosion-resistant galvanized steel strips with precision punched holes quick & easy two minute installation.

◀ FRAME: Channel, 9/16" X 9/16" X 9/16" (14MM X 14MM X 14MM), is constructed from a type 304, 22 gauge stainless steel with mitered corners in Satin or Bright Finish. (Same Cost)

◀ GUARANTEE: Meek gives a one year guarantee on all of their products against defects in workmanship and material. Improper installation voids warranty. Mirror glass is guaranteed 15 years.

◀ SPECIFICATION: Product shall be Model M1500 or M1510 as Manufactured by Meek Mirrors, USA.

